

## 200mA, Low-I<sub>q</sub> 40μA Low-Dropout Regulator with Enable, Reset, Watchdog Functions

### DESCRIPTION

The TQL820CA14V33 is a high-performance low dropout voltage regulator for 3.3V with input range of 3V to 50V and low quiescent 40μA. TQL820CA14V33 provides 2% output voltage accuracy and 200mA maximum driving current and is suitable for automotive or other supply systems.

TQL820CA14V33 just requires one small ceramic capacitor of 1μF to exhibit fast regulation and good stability. And it shows very low-dropout voltage with 70mV in 100mA-load and 110mV in 200mA-load. The start operating voltage is 3V which is suitable to cranking condition of automotive system.

The device has enabled function to switch ON and OFF for power dissipation. And there is Reset function to monitor output voltage for UVLO reset and power-ON delay reset with adjustable lower reset threshold function. The built-in watchdog function monitors microcontroller's operation with flexible timings. And other protection functions such as thermal-shutdown and current-limit are against immediate damage.

### APPLICATION

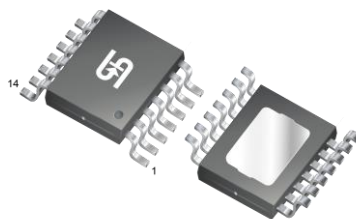
- Automotive Power Supply Systems
- General Power Supply applications

### FEATURES

- AEC-Q100 qualified with the following results:
  - Device temperature grade 1: -40°C to 125°C
  - Device HBM ESD classification level H2
  - Device CDM ESD classification level C3
- 3V to 50V Input Voltage Range
- 3.3V Fixed Output Voltage
- 70mV@100mA Low Dropout Voltage
- 200mA Output Current
- Typical 40μA Low Quiescent Current
- Typical ±2% Output Voltage Accuracy
- 1μF Ceramic Output Stable Capacitor
- Programmable Delayed Reset timing at Power-On
- Adjustable Reset Threshold Voltage
- Flexible Watch-dog Timing and Current Dependent Deactivation
- Output Current Limit
- Enable, Under-voltage Reset.
- Over Temperature Protection
- RoHS Compliant
- Halogen-Free according to IEC 61249-2-21



TSSOP-14EP

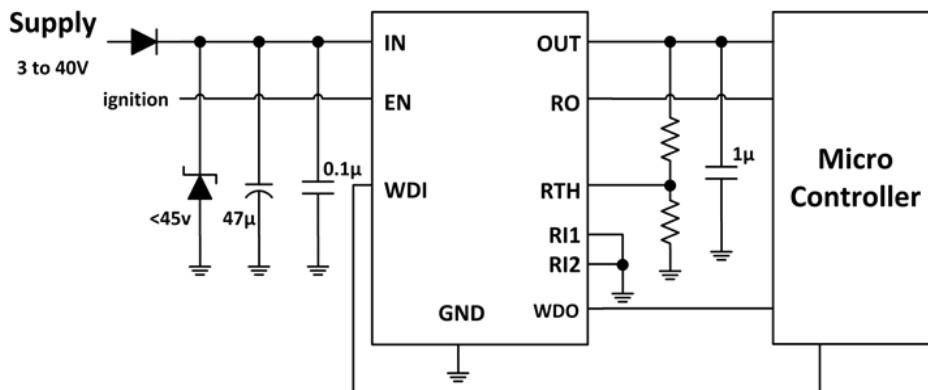


#### Pin Definition:

1.IN	8.RTH
2.NC	9.PI1
3.EN	10.PI2
4.NC	11.RO
5.GND	12.WDO
6.NC	13.NC
7.WDI	14.OUT

**Notes:** Moisture sensitivity level: level 3. Per J-STD-020

**TYPICAL APPLICATION CIRCUIT**



**ABSOLUTE MAXIMUM RATINGS** ( $T_A = 25^\circ\text{C}$  unless otherwise specified) (Note 1)

PARAMETER	SYMBOL	LIMIT	UNIT
Power Supply Pin	$V_{IN}$	55	V
EN Voltage to GND	$V_{EN}$	-0.3 to 55	V
OUT/RO/WDO Voltage to GND	$V_{OUT}/V_{RO}/V_{WDO}$	-0.3 to 7	V
WDI/PI1/PI2/RTH Voltage to GND	$V_{WDI}/V_{PI1}/V_{PI2}/V_{RTH}$	-0.3 to 7	V
Junction Temperature Range	$T_J$	-40 to +150	$^\circ\text{C}$
Storage Temperature Range	$T_{STG}$	-55 to +150	$^\circ\text{C}$
ESD Rating (Human Body Model) (Note 2)	HBM	$\pm 2$	kV
ESD Rating (Charged Device Model)	CDM	$\pm 1$	kV

**THERMAL PERFORMANCE**

PARAMETER	SYMBOL	TYP	UNIT
Junction to Case Thermal Resistance	$R_{\theta JC}$	9	$^\circ\text{C}/\text{W}$
Junction to Ambient Thermal Resistance	$R_{\theta JA}$	50	$^\circ\text{C}/\text{W}$

**Notes:** The thermal data is based on the PCB JESD 51-3 at natural convection on 1s0p board with 1 copper layer (1 x 70μm Cu) and with 300mm<sup>2</sup> heatsink area on PCB

<b>RECOMMENDED OPERATING CONDITIONS</b> (Note 3)			
PARAMETER	SYMBOL	CONDITIONS	UNIT
Power Supply Pin	$V_{IN}$	$V_{OUT} + V_{dr}$ to 50	V
Extended Power Supply Pin	$V_{IN,ext}$	3 to 50	V
EN Voltage to GND	$V_{EN}$	0 to 50	V
Output Stable Capacitor	$C_{OUT}$	$\geq 1$	$\mu F$
ESR of Output Capacitor	ESR	$\leq 100$	$\Omega$
Operating Junction Temperature Range	$T_J$	-40 to +150	$^{\circ}C$
Operating Ambient Temperature Range	$T_{OPA}$	-40 to +125	$^{\circ}C$

<b>ELECTRICAL SPECIFICATIONS</b> ( $V_{IN} = 13.5V$ , $T_J = -40$ to $150^{\circ}C$ unless otherwise noted)						
PARAMETER	CONDITIONS	SYMBOL	MIN	TYP	MAX	UNIT
<b>Supply Voltage</b>						
Output Voltage	$0.05mA < I_{OUT} < 200mA$ $3.72V < V_{IN} < 28V$	$V_{OUT}$	3.23	3.3	3.37	V
Output Voltage	$0.05mA < I_{OUT} < 100mA$ $3.55V < V_{IN} < 40V$	$V_{OUT}$	3.23	3.3	3.37	V
Start-up Slew-rate	$V_{IN} > 18V/ms$ , $C_{OUT} = 1\mu F$ $0.5V < V_{OUT} < 4.5V$	$dV_{OUT}/dt$	--	35	--	V/ms
Current Limit	$0V < V_{OUT} < 4.8V$	$I_{lim}$	--	320	--	mA
Load Regulation	$I_{OUT} = 0.05$ to $200mA$ $V_{IN} = 6V$	$\Delta V_{OUT,lo}$	-15	-1.5	5	mV
Line Regulation	$V_{IN} = 8$ to $32V$ $I_{OUT} = 1mA$	$\Delta V_{OUT,li}$	-15	0	15	mV
Dropout Voltage ( $V_{dr} = V_{IN} - V_{OUT}$ )	$I_{OUT} = 200mA$	$V_{dr}$	--	110	340	mV
Dropout Voltage ( $V_{dr} = V_{IN} - V_{OUT}$ )	$I_{OUT} = 100mA$	$V_{dr}$	--	70	170	mV
Power Supply Ripple Rejection	$f = 100Hz$ $V = 0.5V_{pp}$	PSRR	--	59	--	dB
Thermal Shutdown Threshold (Note 4)		$T_{th}$	151	--	200	$^{\circ}C$
Thermal Shutdown Hysteresis (Note 4)		$T_{hy}$	--	30	--	$^{\circ}C$
<b>Current Consumption (PI1=PI2=WDI=GND)</b>						
Standby Current ( $I_O = I_{IN}$ )	$V_{EN} = 0V$ ; $T_J < 105^{\circ}C$	$I_{O,st}$	--	1.3	5	$\mu A$
Standby Current ( $I_O = I_{IN}$ )	$V_{EN} = 0.4V$ ; $T_J < 125^{\circ}C$	$I_{O,st}$	--	--	8	$\mu A$
Quiescent Current ( $I_O = I_{IN} - I_{OUT}$ )	$I_{OUT} = 0.05mA$ $T_J = 25^{\circ}C$	$I_O$	--	40	52	$\mu A$
Quiescent Current ( $I_O = I_{IN} - I_{OUT}$ )	$I_{OUT} = 0.05mA$ $T_J < 125^{\circ}C$	$I_O$		60	77	$\mu A$

<b>ELECTRICAL SPECIFICATIONS</b> ( $V_{IN} = 13.5V$ , $T_J = -40$ to $150^{\circ}C$ unless otherwise noted)						
<b>PARAMETER</b>	<b>CONDITIONS</b>	<b>SYMBOL</b>	<b>MIN</b>	<b>TYP</b>	<b>MAX</b>	<b>UNIT</b>
<b>Enable</b>						
High Level Input Voltage		$V_{ENH}$	2	--	--	V
Low Level Input Voltage	$V_{OUT} \leq 0.1V$	$V_{ENL}$	--	--	0.8	V
Threshold Hysteresis		$V_{ENHy}$	100	--	--	mV
EN Input Current	$V_{EN} = 3.3V$	$I_{EN}$	--	--	3.5	$\mu A$
EN Input Current	$V_{EN} \leq 18V$	$I_{EN}$	--	--	22	$\mu A$
EN Pull-down Resistor		$R_{EN}$	0.95	1.5	2.6	$M\Omega$
<b>Reset</b>						
UVLO Reset Upper Threshold	$V_{OUT}$ increasing	$V_{RTH}$	3.05	3.1	3.22	V
UVLO Reset Lower Threshold	$V_{OUT}$ decreasing $R_{TH} = GND$	$V_{RTL}$	2.92	3.02	3.13	V
UVLO Reset Threshold Hysteresis	$R_{TH} = GND$	$V_{RTHy}$	60	100	--	mV
UVLO Reset Headroom ( $V_{OUT} - V_{RTL}$ )	$R_{TH} = GND$	$V_{RH}$	200	400	--	mV
UVLO Adjustment Threshold		$V_{RTTH}$	1.15	1.2	1.25	V
UVLO Adjustment Range		$V_{RTRG}$	2.5	--	2.9	V
Reset Output Low Voltage	$1V \leq V_{OUT} \leq V_{RTL}$ $R_{RO} \geq 5.1k\Omega$	$V_{ROL}$	--	0.2	0.4	V
Internal Pull-up Resistor	Connected to OUT	$R_{RO,int}$	13	20	36	$k\Omega$
External Pull-up Resistor to OUT	$1V \leq V_{OUT} \leq V_{RTL}$ $V_{RO} \leq 0.4V$	$R_{RO,ext}$	5.1	--	--	$k\Omega$
<b>Reset Delay Timing</b>						
Reset Delay Time	PI1 to GND	$t_{RD,slow}$	13.2	16.5	20.2	ms
Reset Delay Time	PI1 to OUT	$t_{RD,fast}$	6.8	8.5	11.5	ms
Reset Blanking Time (Note 4)	$V_{O,nom} = 5V$	$t_{RB}$	--	7	--	$\mu s$
Internal Reset Reaction Time (Note 4)	$V_{O,nom} = 5V$	$t_{RR}$	--	10	33	$\mu s$
<b>Reset Delay Input PI1</b>						
PI1 High Signal Valid		$V_{PI1H}$	2.0	--	--	V
PI1 Low Signal Valid		$V_{PI1L}$	--	--	0.8	V
PI1 Signal Slew Rate (Note 4)	$V_{PI1L} < V_{PI1} < V_{PI1H}$	$dV_{PI1}/dt$	1	--	--	$V/\mu s$
PI1 Input Current	$V_{PI1} = 3.3V$	$I_{PI1}$	--	--	3.5	$\mu A$
PI1 Pull-down Resistor		$R_{PI1}$	0.9	1.5	2.6	$M\Omega$

<b>ELECTRICAL SPECIFICATIONS</b> ( $V_{IN} = 13.5V$ , $T_J = -40$ to $150^{\circ}C$ unless otherwise noted)						
<b>PARAMETER</b>	<b>CONDITIONS</b>	<b>SYMBOL</b>	<b>MIN</b>	<b>TYP</b>	<b>MAX</b>	<b>UNIT</b>
<b>Watchdog</b>						
Watchdog Ignore Time		$t_{WDI,i}$	12.8	16	20.7	ms
Watchdog Trigger Time	PI1 to GND PI2 to GND	$t_{WDI,tr1}$	76.8	96	124.4	ms
Watchdog Trigger Time	PI1 to OUT PI2 to GND	$t_{WDI,tr2}$	38.4	48	62.2	ms
Watchdog Trigger Time	PI1 to GND PI2 to OUT	$t_{WDI,tr3}$	25.6	32	41.5	ms
Watchdog Trigger Time	PI1 to OUT PI2 to OUT	$t_{WDI,tr4}$	12.8	16	20.7	ms
Watchdog Low Time		$t_{WDO,low}$	6.4	8	10.4	ms
<b>Watchdog Input</b>						
Activation Current Threshold	$V_{IN} > 5.44V$	$I_{WD,ac}$	--	--	7	mA
Deactivation Current Threshold	$V_{IN} > 5.44V$	$I_{WD,de}$	1	--	--	mA
Current Threshold Hysteresis	$V_{IN} > 5.44V$	$I_{WD,Hy}$	0.35	--	--	mA
Minimum Filter Time By Current (Note 4)		$t_{FI,min}$	100	--	--	$\mu s$
Maximum Filter Time By Current (Note 4)		$t_{FI,max}$	--	--	500	$\mu s$
WDI High Signal Valid		$V_{WDIH}$	2.0	--	--	V
WDI Low Signal Valid		$V_{WDIL}$	--	--	0.8	V
WDI High Pulse Length (Note 4)	$V_{WDI} \geq V_{WDIH}$	$t_{WDI,ph}$	1	--	--	$\mu s$
WDI Low Pulse Length (Note 4)	$V_{WDI} \leq V_{WDIL}$	$t_{WDI,pl}$	1	--	--	$\mu s$
WDI Signal Slew Rate (Note 4)	$V_{WDIL} < V_{WDI} < V_{WDIH}$	$dV_{WDI}/dt$	1	--	--	V/ $\mu s$
WDI Input Current	$V_{WDI} = 3.3V$	$I_{WDI}$	--	--	3.5	$\mu A$
WDI Pull Down Resistor		$R_{WDI}$	0.9	1.5	2.6	M $\Omega$
WDI Disable Threshold	$V_{IN} > 5.44V$	$V_{WD,dis}$	1.15	--	1.4	V
Minimum Filter Time By WDI (Note 4)		$t_{FWDI,min}$	100	--	--	$\mu s$
Maximum Filter Time By WDI (Note 4)		$t_{FWDI,max}$	--	--	500	$\mu s$
<b>Watchdog Delay Input PI2</b>						
PI2 High Signal Valid		$V_{PI2H}$	2.0	--	--	V
PI2 Low Signal Valid		$V_{PI2L}$	--	--	0.8	V
PI2 Signal Slew Rate	$V_{PI2L} < V_{PI2} < V_{PI2H}$	$dV_{PI2}/dt$	1	--	--	V/ $\mu s$
PI2 Input Current	$V_{Pix} = 3.3V$	$I_{PI2}$	--	--	3.5	$\mu A$
PI2 Pull-down Resistor		$R_{PI2}$	0.9	1.5	2.6	M $\Omega$
PI1,2 Setup and Hold Time (Note 4)		$t_{PI,SH}$	150	--	--	$\mu s$

<b>ELECTRICAL SPECIFICATIONS</b> ( $V_{IN} = 13.5V$ , $T_J = -40$ to $150^{\circ}C$ unless otherwise noted)						
<b>PARAMETER</b>	<b>CONDITIONS</b>	<b>SYMBOL</b>	<b>MIN</b>	<b>TYP</b>	<b>MAX</b>	<b>UNIT</b>
<b>Watchdog Output</b>						
Watchdog Output Low Voltage	$R_{WDO} > 5.1k\Omega$	$V_{WDOL}$	--	0.2	0.4	V
Internal Pull-up Resistor	Connected to output pin	$R_{WDO,int}$	13	20	36	k $\Omega$
External Pull-up Resistor to Output	$V_{WDO} \leq 0.4V$	$R_{WDO,ext}$	5.1	--	--	k $\Omega$

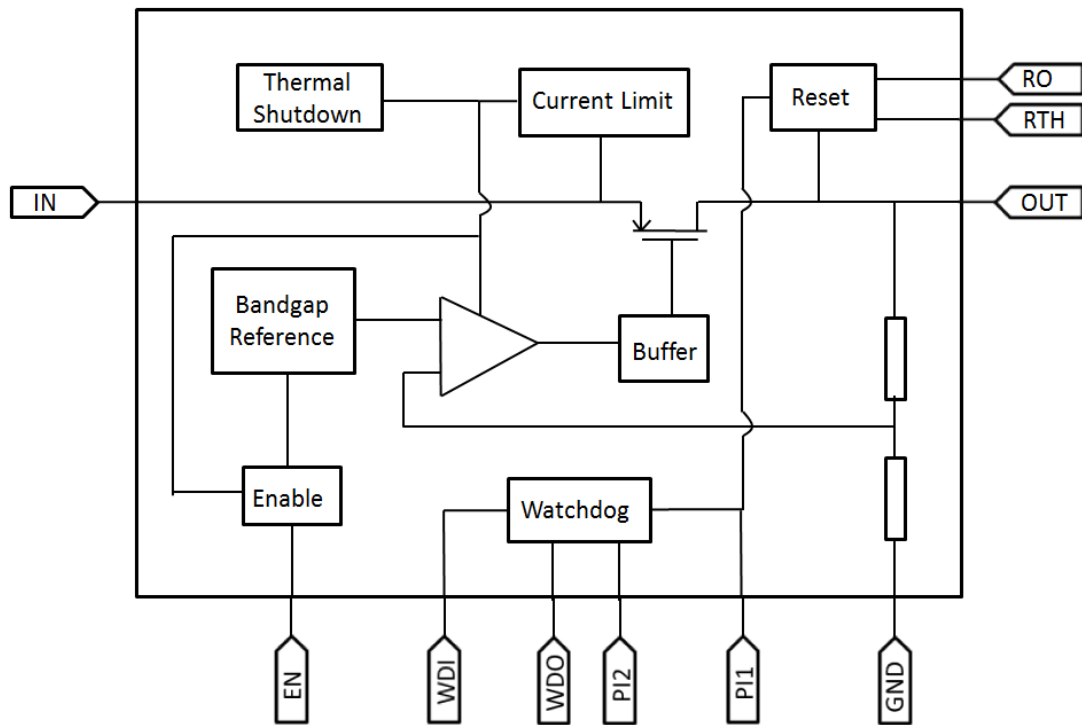
**Note:**

1. Stresses listed as the above "Absolute Maximum Ratings" may cause permanent damage to the device. These are for stress ratings. Functional operation of the device at these or any other conditions beyond those indicated in the operational sections of the specifications is not implied. Exposure to absolute maximum rating conditions for extended periods may remain possibility to affect device reliability.
2. Devices are ESD sensitive. Handling precaution recommended.
3. The device is not guaranteed to function outside its operating conditions.
4. Guaranteed by design.

**ORDERING INFORMATION**

<b>ORDERING CODE</b>	<b>PACKAGE</b>	<b>PACKING</b>
TQL820CA14V33 RLG	TSSOP-14EP	2,500pcs / 13" Reel

**BLOCK DIAGRAM**



**PIN DESCRIPTION**

PIN NO.	NAME	FUNCTION
1	IN	Power supply pin for system
2	NC	Not connected
3	EN	Enable system function
4	NC	Not connected
5	GND	Ground
6	NC	Not connected
7	WDI	Watchdog monitor input
8	RTH	Reset threshold adjustment
9	PI1	Program input 1 for timing adjustment
10	PI2	Program input 2 for timing adjustment
11	RO	Reset output
12	WDO	Watchdog output
13	NC	Not connected
14	OUT	Output supply voltage
Pad	--	Connect to heatsink area and ground.

## APPLICATION INFORMATION

TQL820CA14V33 is a high-performance low dropout voltage regulator. The device operates with a wide input voltage from 3V to 50V and up to 200mA of output current. It also provides a high accuracy output voltage for  $\pm 2\%$  in all the load and line regulation.

### Enable

The EN pin is high voltage tolerant pin. High input enables the device ON and low is disable which can be connected to microcontroller or digital control system. It can be connected to input power pin directly.

### Reset

The TQL820CA14V33 is monitored by Reset system including Power-ON Delayed Reset, Under-Voltage Reset, and Reset Threshold Adjustment. When reset is activated, the RO pin is low.

#### ■ Power-ON Delayed Reset

When device starts up, the RO pin delays becoming “High” in Power-ON Delayed Time ( $t_{RD}$ ) without reset issue. The timing can be controlled by PI1 pin.

PI1 connected to	$t_{RD}$
GND	16.5ms
OUT	8.5ms

#### ■ Under-Voltage Reset

When the output supply voltage drops below UVLO Reset Lower Threshold ( $V_{RTL}$ ), the RO switches from “High” to “Low”. The RO pin is an open collector output with an internal pull-up resistor.

#### ■ Reset Threshold Adjustment

- The UVLO Reset Lower Threshold ( $V_{RTL}$ ) is adjustable by the configuration of the RTH pin.
- The threshold voltage is set as default if the RTH pin connects to GND directly.
- $V_{RTL}$  can be also set for an expected threshold value by voltage dividers,  $R_{th1}$  and  $R_{th2}$ , with the appropriate resistance and sourcing current.
- $R_{th1}$  is connected between OUT pin and RTH pin; meanwhile,  $R_{th2}$  is connected between RTH and GND.
- The new threshold voltage ( $V_{RTL}$ ) is calculated as following:

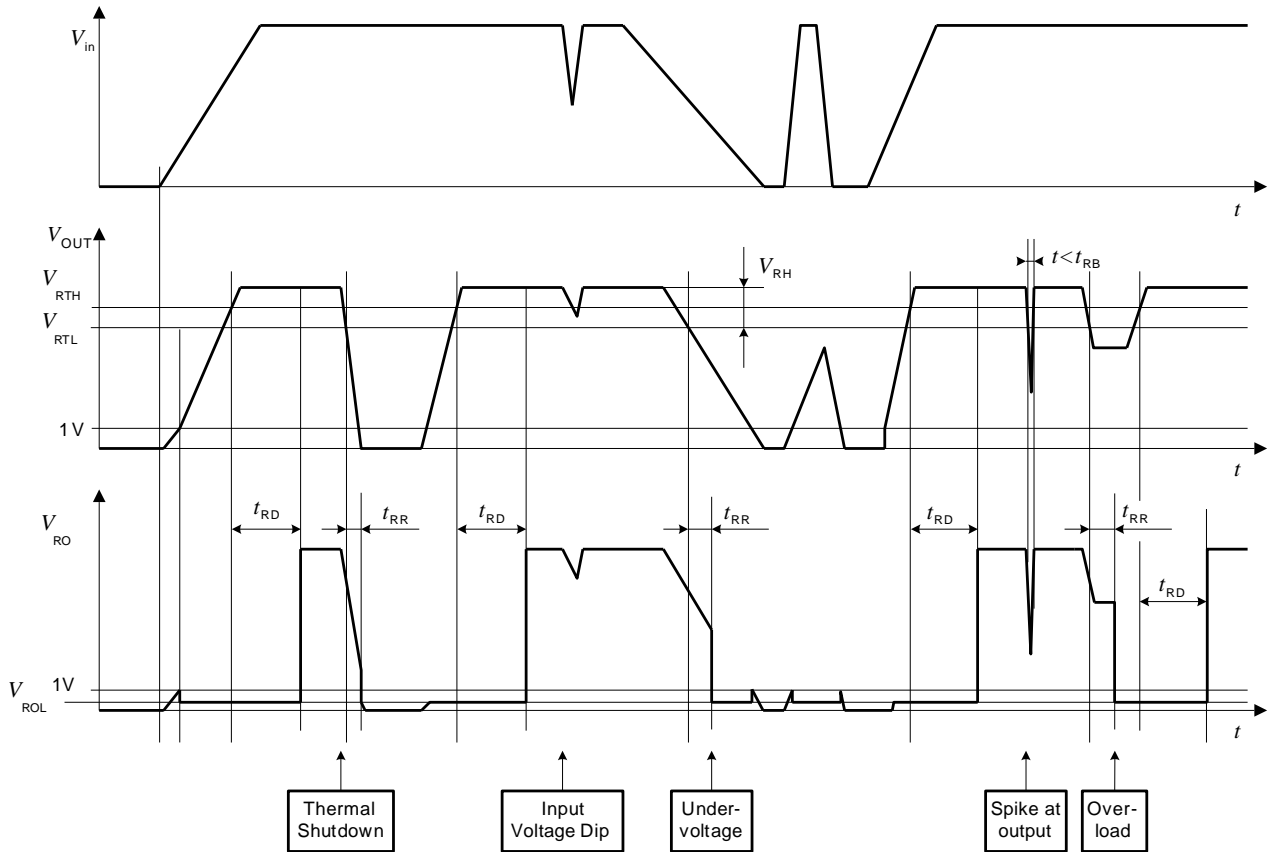
$$V_{RTL, new} = V_{RTTH} \times (R_{th1} + R_{th2}) / R_{th2}$$

- $V_{RTL, new}$  : Expected UVLO Reset Lower Threshold
- $R_{th1}, R_{th2}$  : External Divider Resistors
- $V_{RTTH}$  : UVLO Adjustment Threshold



**APPLICATION INFORMATION (CONTINUE)**

**Typical Timing Diagram Reset**



**Thermal Shutdown (TSD)**

Internal 160°C comparator will trigger temperature protection (TSD). TSD will shut down system, until internal temperature back to 130°C.

**Current Limit**

The TQL820CA14V33 features Current Limit function to protect device from damage by excessive power dissipation such as OUT shorted to GND. It limits output current to maintain power dissipation in the safe region.

**APPLICATION INFORMATION (CONTINUE)**

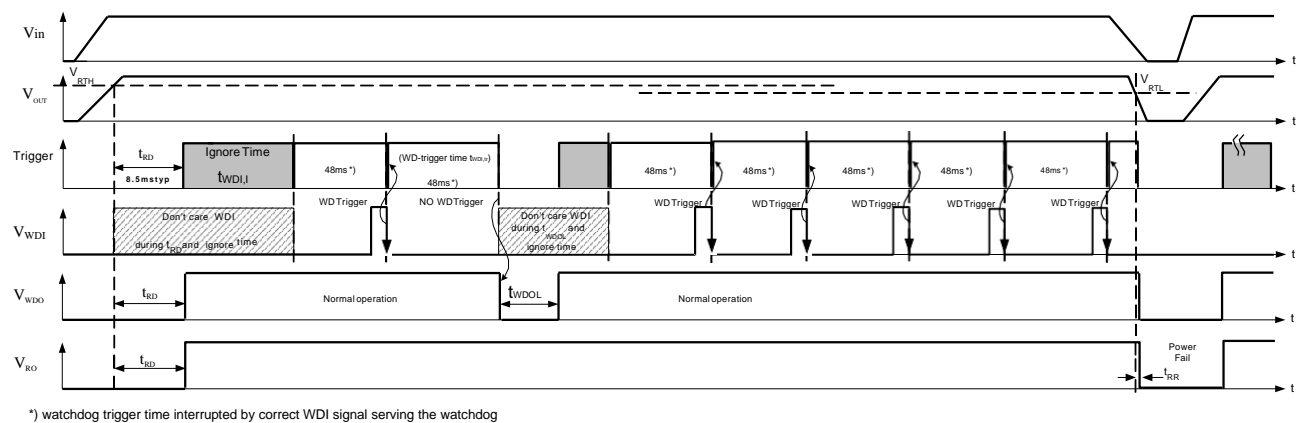
**Watchdog**

The TQL820CA14V33 has the load dependent watchdog function with programmable watchdog timing to monitor microcontroller process. The device monitors the period clock-pulse provided by Microcontroller at WDI pin in a certain timing (Watchdog Trigger Time,  $t_{WDI,tr}$ ). If there is no signal in Watchdog Trigger Time, the WDO pin becomes “Low” in a certain time (Watchdog Low Time,  $t_{WDOL}$ ). After that, the WDO pin returns to “High” and keep watching the WDI signal repeatedly. The WDO pin is an open collector output with an internal pull-up resistor.

The Watchdog function is inactivated by two methods: WDI voltage and output load current. While the WDI voltage is in 1.15V to 1.4V or load current is lower than 1mA, the Watchdog function is disabled.

The Watchdog Trigger Time is programmable with PI1 and PI2. The timing selection as follows:

PI1 connected to	PI2 connected to	$t_{WDI,tr}$
GND	GND	96ms
OUT	GND	48ms
GND	OUT	32ms
OUT	OUT	16ms



\*) watchdog trigger time interrupted by correct WDI signal serving the watchdog

**Typical Watchdog Timing Diagram, Watchdog and Reset Modes**

**TYPICAL OPERATING CHARACTERISTICS**

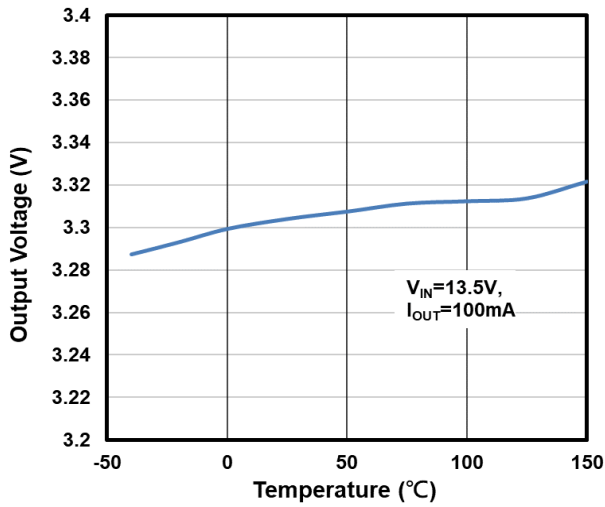


Figure 1. Output Voltage vs. Junction Temperature

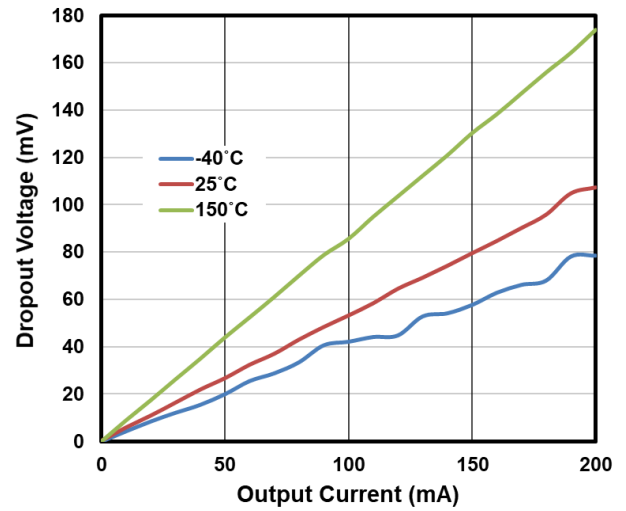


Figure 2. Dropout Voltage vs. Output Current

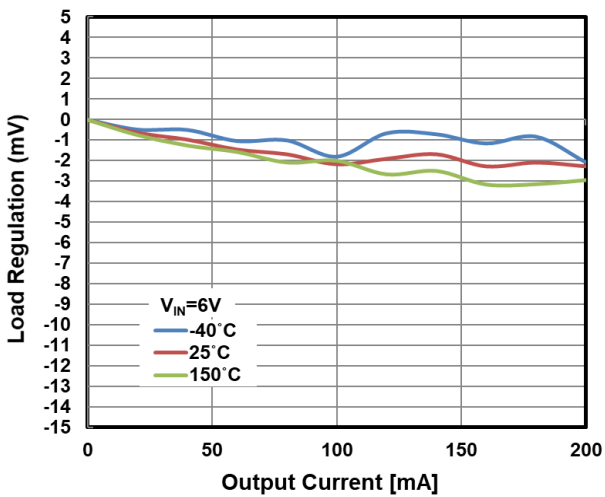


Figure 3. Load Regulation vs. Output Current

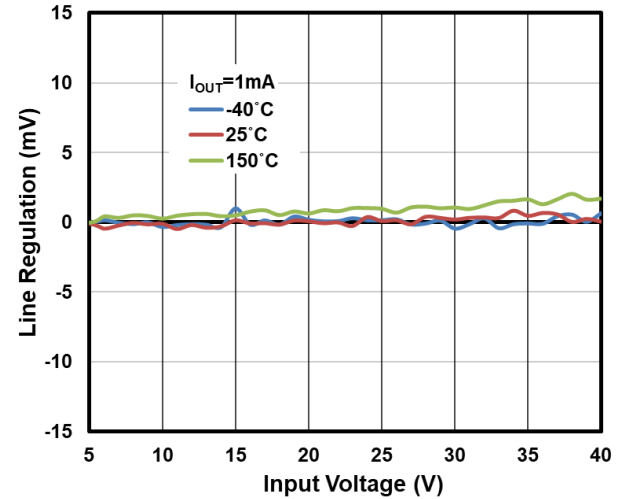


Figure 4. Line Regulation vs. Input Voltage

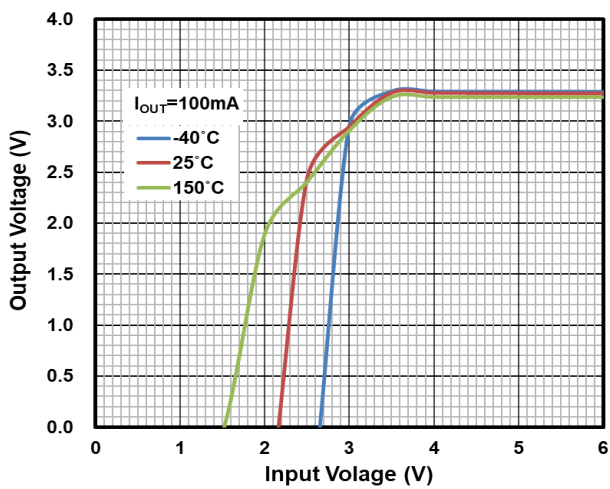


Figure 5. Output Voltage vs. Input Voltage

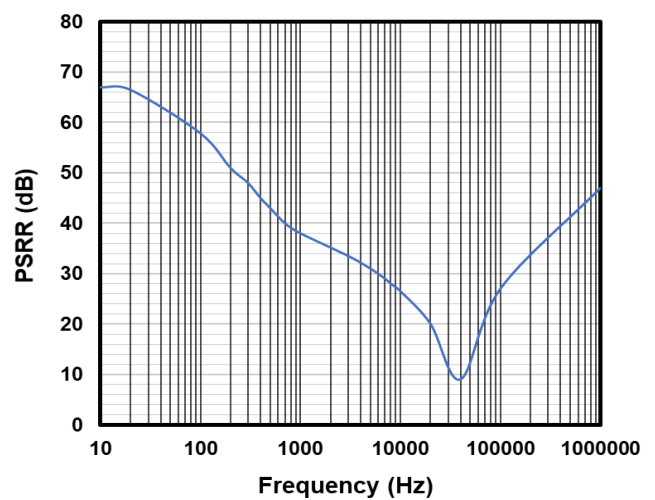
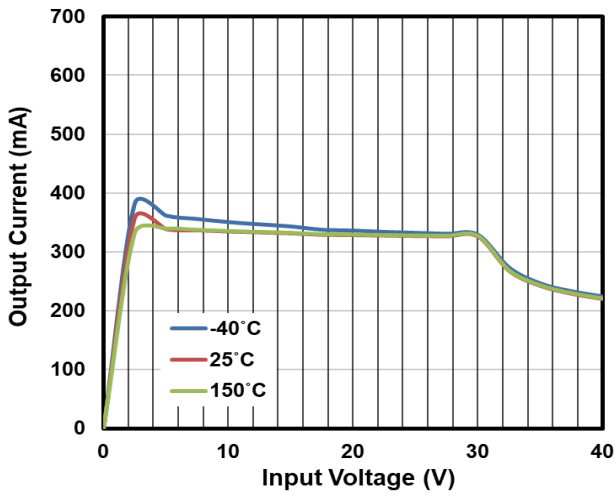
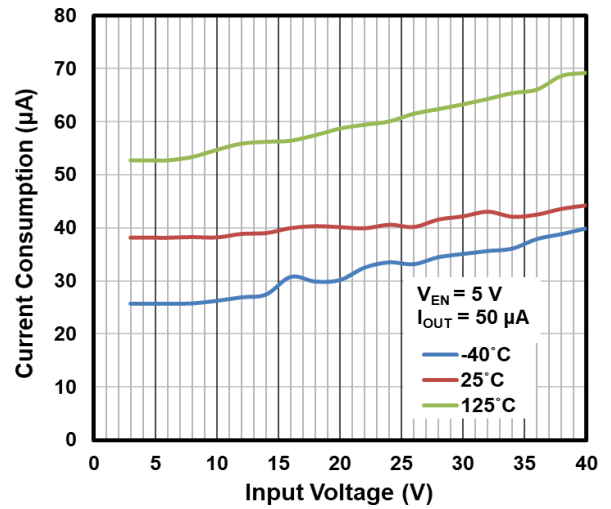


Figure 6. Ripple Rejection vs. Frequency

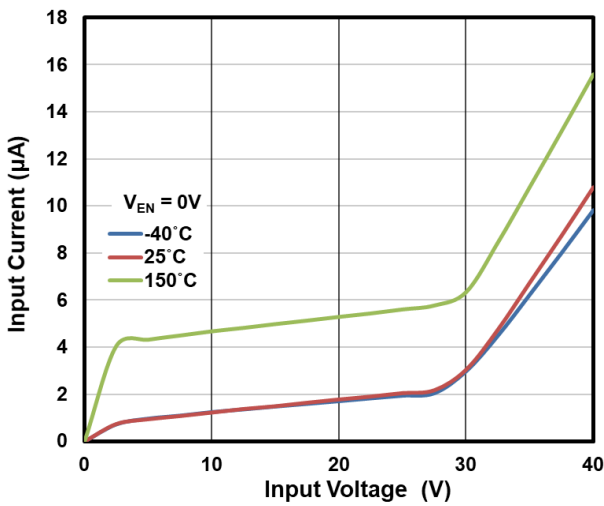
**TYPICAL OPERATING CHARACTERISTICS (CONTINUE)**



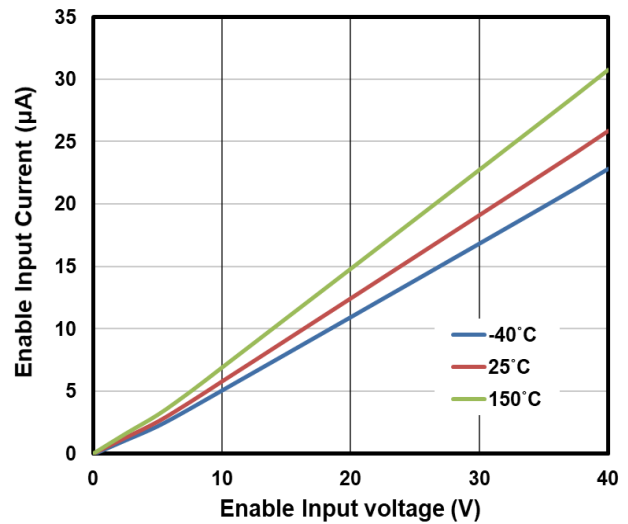
**Figure 7. Output Current vs. Input Voltage**



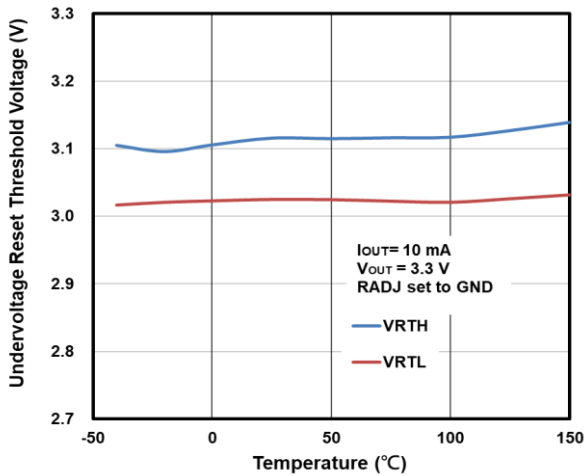
**Figure 8. Current Consumption vs. Input Voltage**



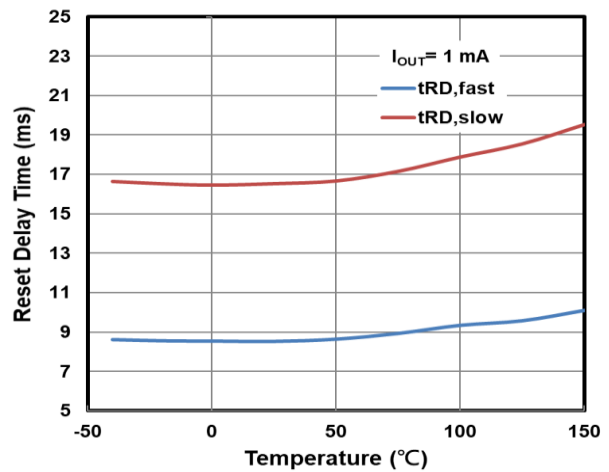
**Figure 9. Input Current vs. Input Voltage**



**Figure 10. Enabled Input Current vs. Enabled Input Voltage**

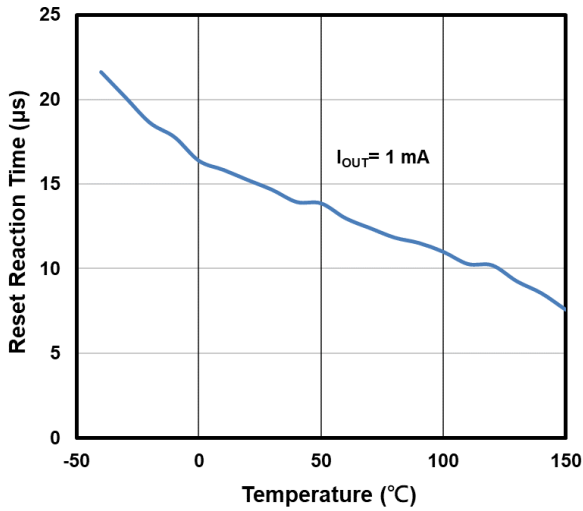


**Figure 11. Undervoltage Reset Threshold vs. Junction Temperature**

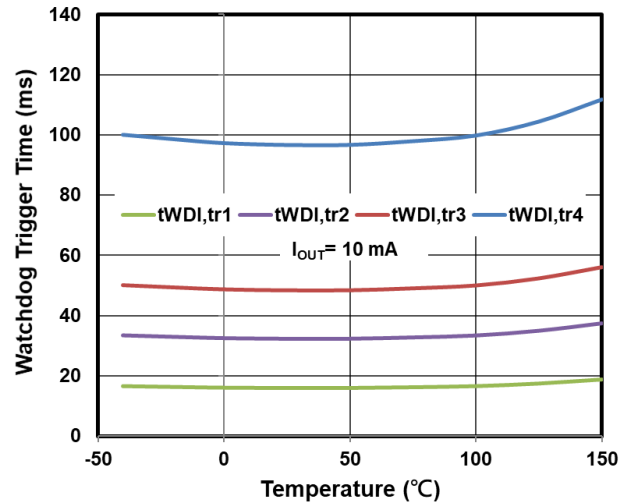


**Figure 12. Power On Reset Delay Time vs. Junction Temperature**

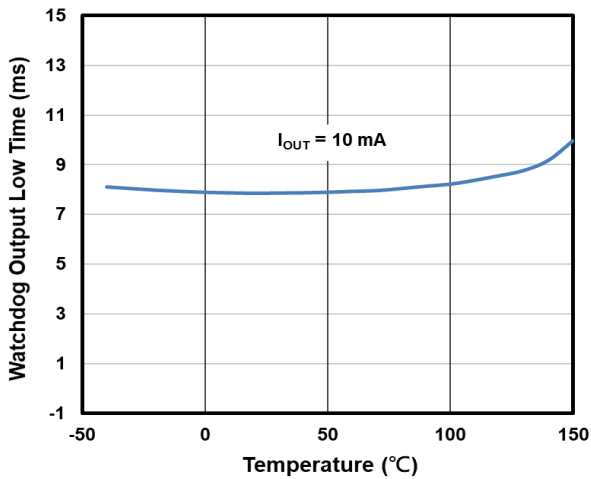
**TYPICAL OPERATING CHARACTERISTICS(CONTINUE)**



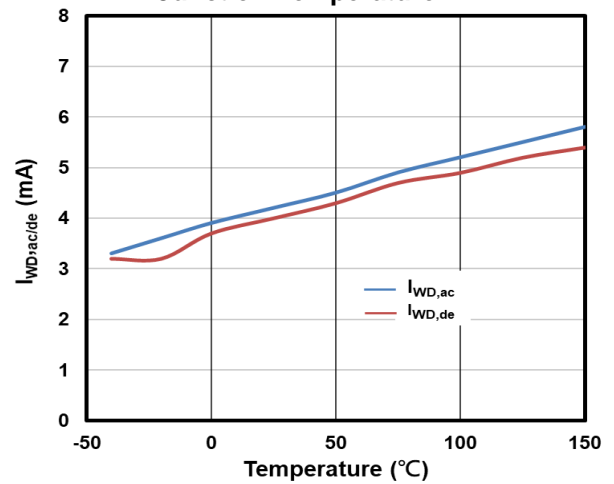
**Figure 13. Internal Reset Reaction Time vs. Junction Temperature**



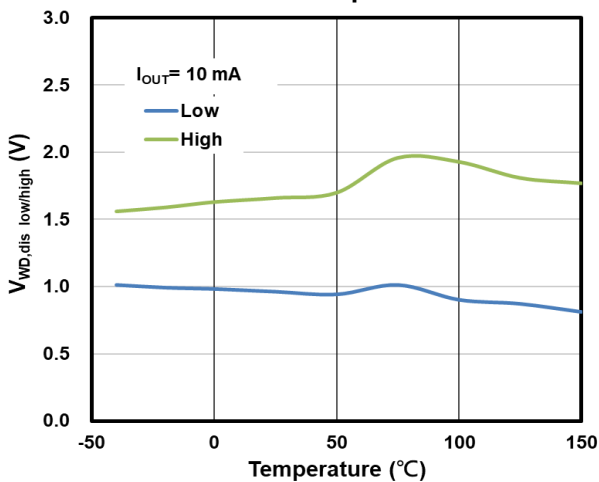
**Figure 14. Watchdog Trigger Time 1,2,3,4 vs. Junction Temperature**



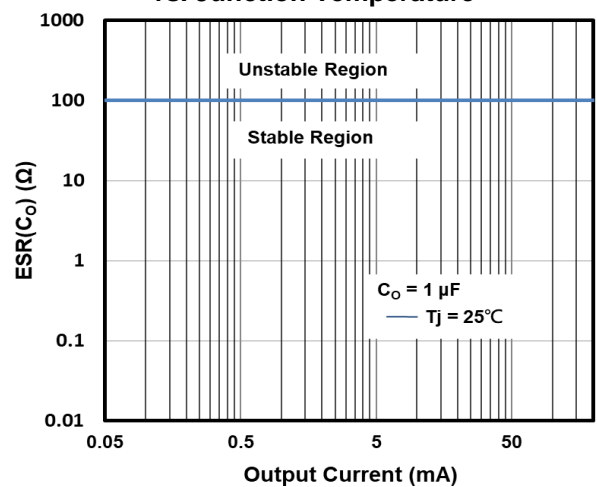
**Figure 15. Watchdog Output Low Time vs. Junction Temperature**



**Figure 16. Watchdog Activation/Deactivation Current vs. Junction Temperature**

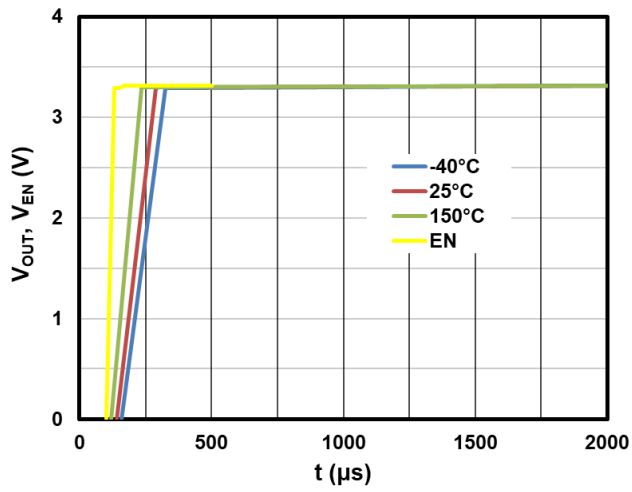


**Figure 17. Watchdog Disable  $V_{WD,dis}$  low/high Threshold vs. Junction Temperature**



**Figure 18. Output Capacitor Series Resistor ESR( $C_O$ ) vs. Output Current**

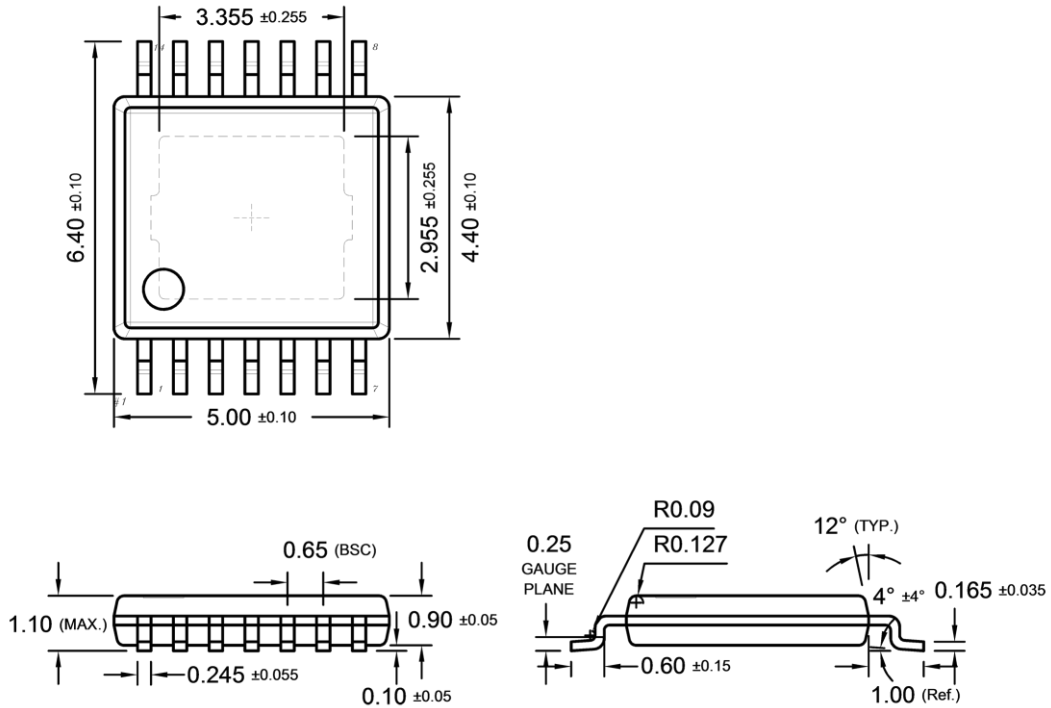
**TYPICAL OPERATING CHARACTERISTICS(CONTINUE)**



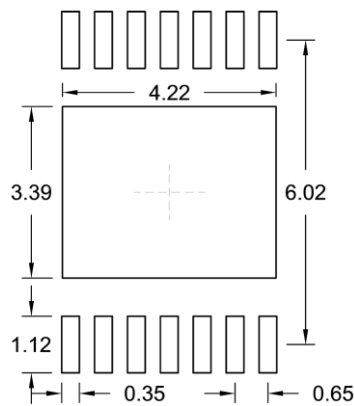
**Figure 19. Output Voltage vs. time (EN switched ON)**

**PACKAGE OUTLINE DIMENSIONS** (Unit: Millimeters)

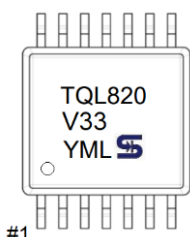
**TSSOP-14EP**



**SUGGESTED PAD LAYOUT** (Unit: Millimeters)



**MARKING DIAGRAM**



- Y = Year Code
- M = Month Code for Halogen Free Product
  - O =Jan    P =Feb    Q =Mar    R =Apr
  - S =May    T =Jun    U =Jul    V =Aug
  - W =Sep    X =Oct    Y =Nov    Z =Dec
- L = Lot Code (1~9, A~Z)